

一般 男子

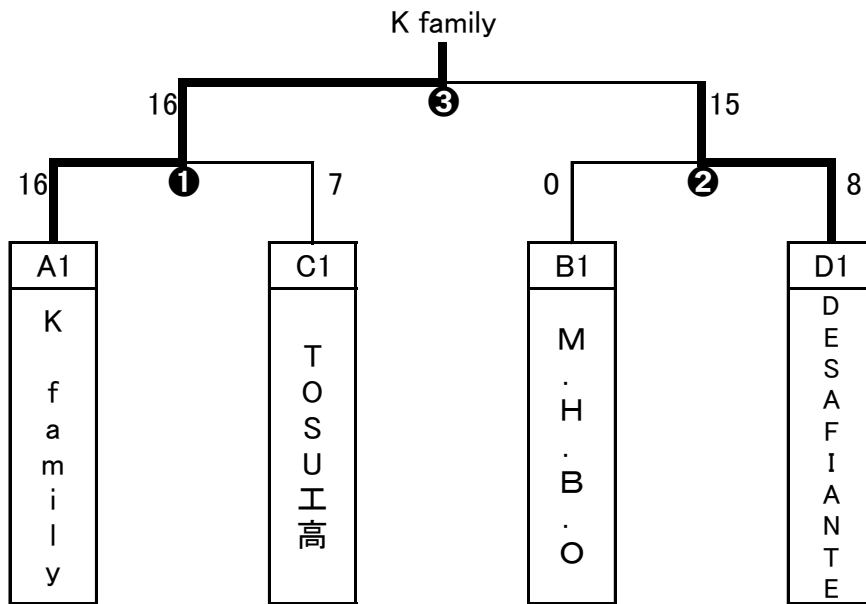
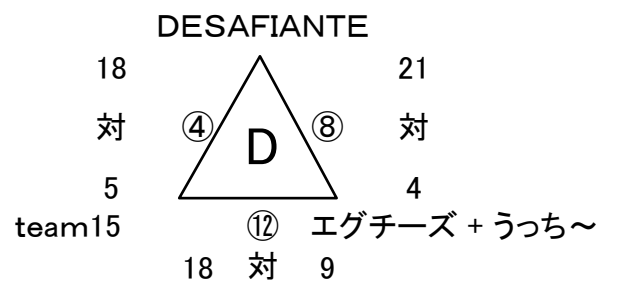
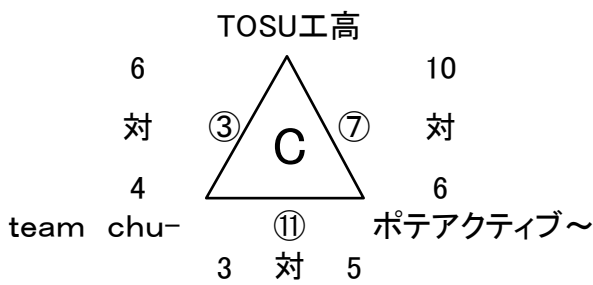
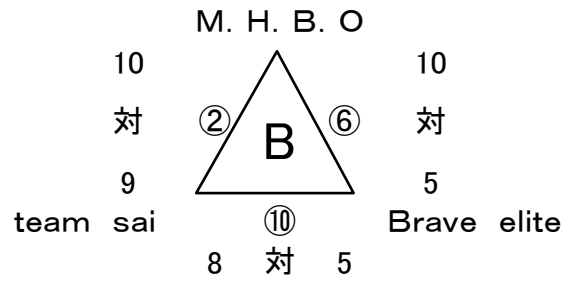
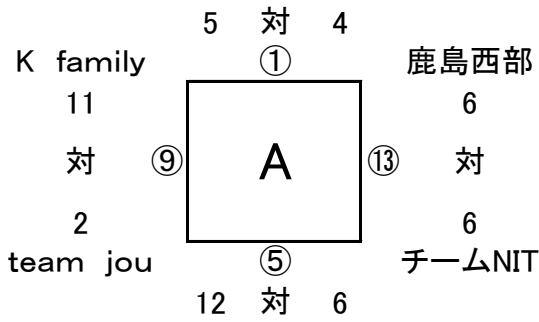

1位: K family

2位: DESAFIANTE

※1位のK familyは3月に行われます、3×3日本選手権大会の出場権を獲得しますが、出場辞退により、繰り上がりで2位のDESAFIANTEが出場権を獲得しました。

一般 女子

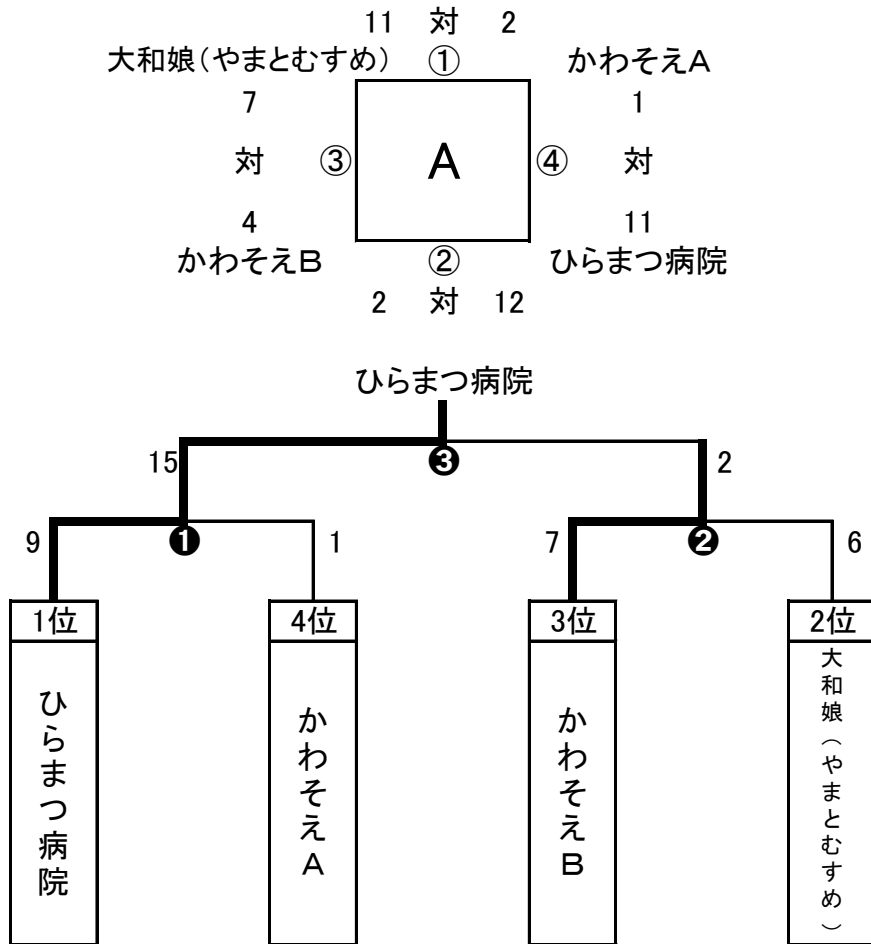

1位: ひらまつ病院

2位: かわそえB

※1位のひらまつ病院は3月に行われます、3×3日本選手権大会の出場権を獲得しました。

小学生 男子

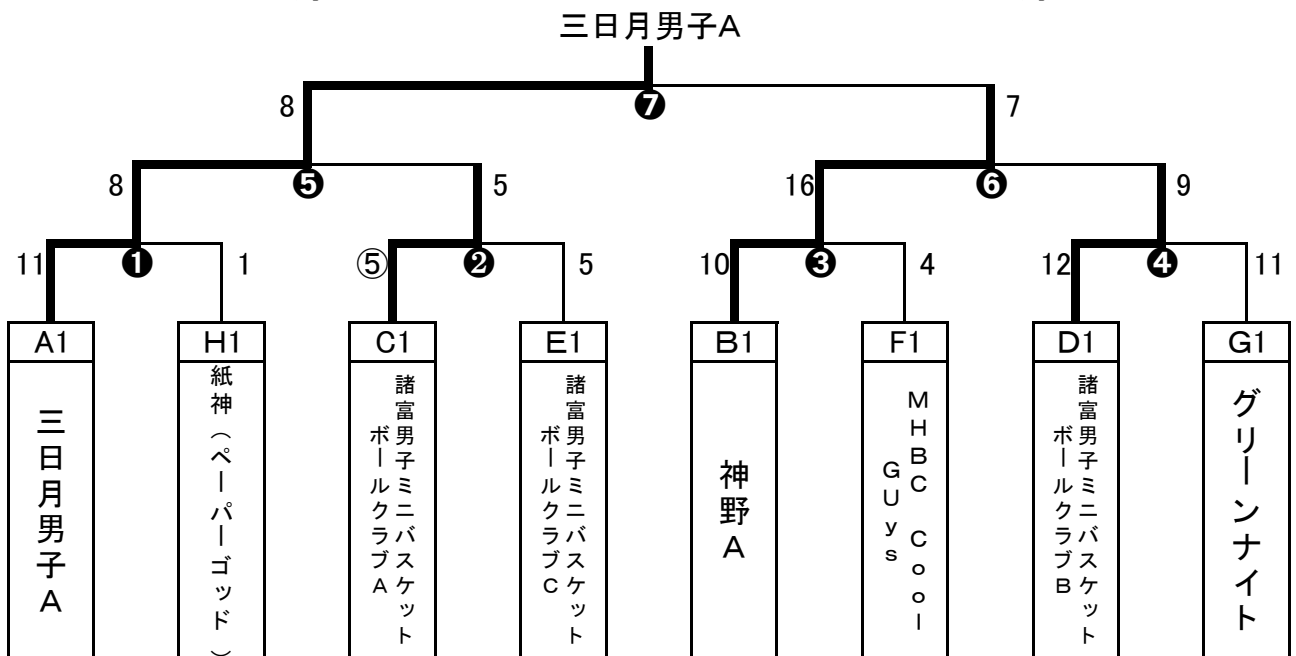
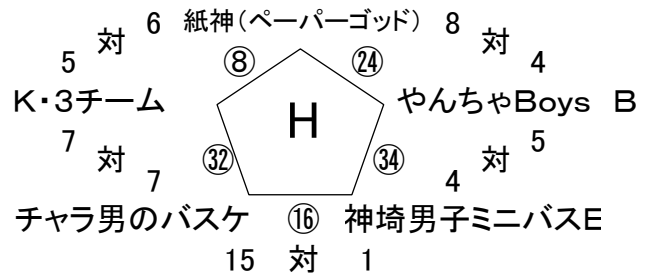
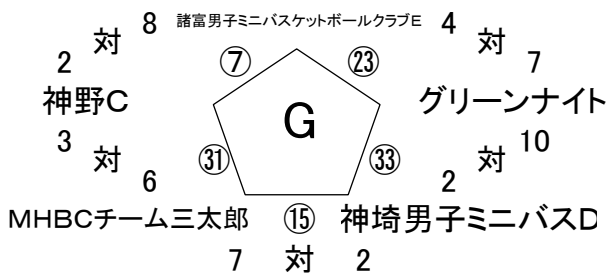
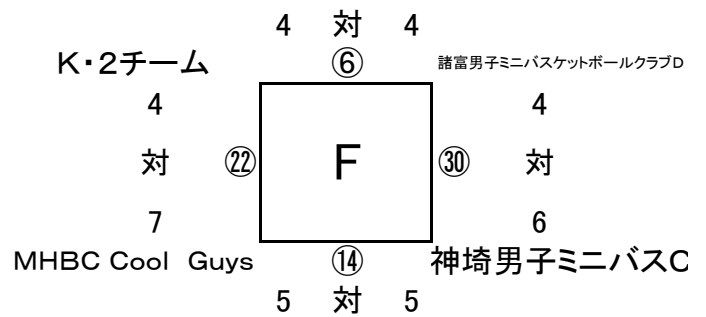
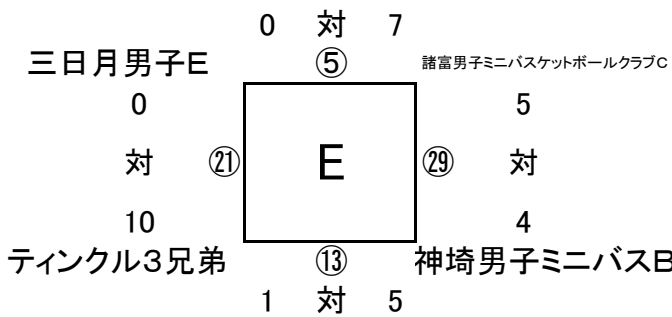
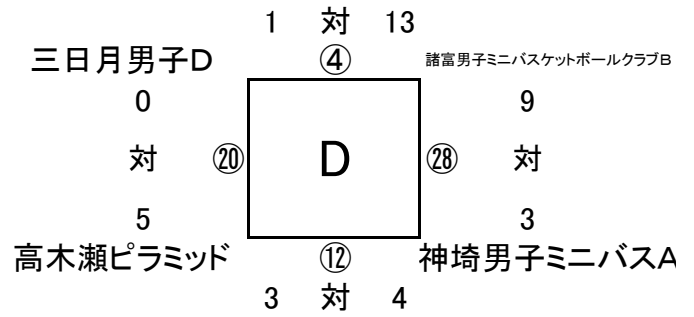
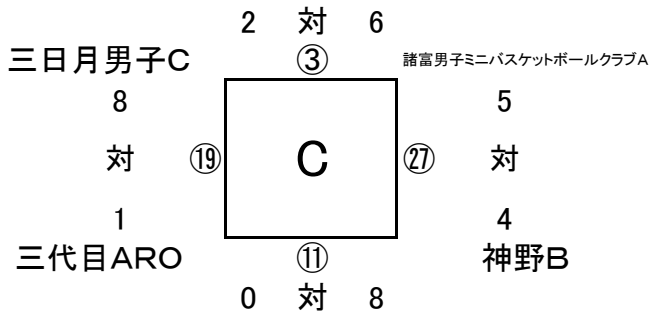
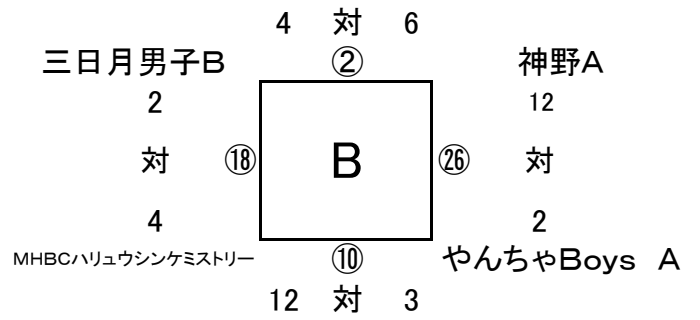
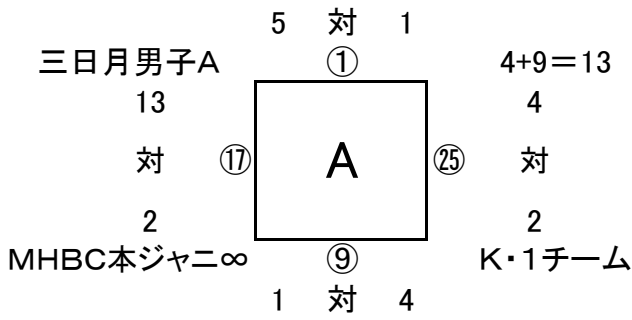

小学生 女子

